

- ❖ 8x NOC 24 V Relay Outputs
- ❖ 1x Slot for IF Module⁽¹⁾
- ❖ Operating Range -40°C to $+70^{\circ}\text{C}$
- ❖ 600 W Integrated Surge Protections



BOX Version



PCB Version

RE8.2 is an industrial module which can be easily adapted for a wide range of tasks. It can be used as IPLOG-G submodule or as standalone IP addressable module at MODBUS / MIOS-2 IO bus.

RE8.2E is a cost-optimized version of RE8.2 without its own CPU. It can be used only as an IPLOG-G submodule.

PRODUCT NAME	CODE	NOTE
RE8.2-01-BOX	5000-1001	2x RS485
RE8.2-01G-BOX	5000-1002	2x RS485 (isolated)
RE8.2-PCB	0000-1000	PCB Module
RE8.2E-PCB ⁽²⁾	0000-0900	PCB Module

For a Full Range of Interfaces Please Visit www.iplog.eu.

ORDERING

DEVICE	PARAMETER	VALUES	NOTE
	Power Supply	12, 24, 48 VDC	10 to 60 VDC
	Consumption	Max. 1.5 W	
	Surge Protection	600 W	10/1000 μs
	Operating Range	-40 to $+70^{\circ}\text{C}$	
	Storage Range	-40 to $+70^{\circ}\text{C}$	
	Humidity	Max. 95 %	No-condensing
	Dimension	35 x 110 x 119 mm	W x H x D
	Weight	Max. 0.38 kg	
	Installation	DIN35 or Flat Surface	
	Device Class	I	EN 61140
	Ingress Protection	IP 20	EN 60529
	Degree of pollution	II	EN 60664-1
Connections	Screw Terminals		
Conduct. cross-section	Max. 2.5 mm ²		

CPU	PARAMETER	VALUES	NOTE
	Series	32-bit MCU	
	Frequency	64 MHz	
	Flash	512 kB	
RAM	64 kB		

Safety Precautions



If dangerous voltage is applied to the terminals, only personnel with appropriate electrical education may perform installation and servicing of the equipment. In the case of a fault, the device must be sent to the producer for repair. The device must be earthed in accordance with national standards. We recommend the manipulation of terminal blocks, only in the event they are not in the presence of dangerous voltage. Failure to comply with this recommendation may result in the risk of electrical shock.

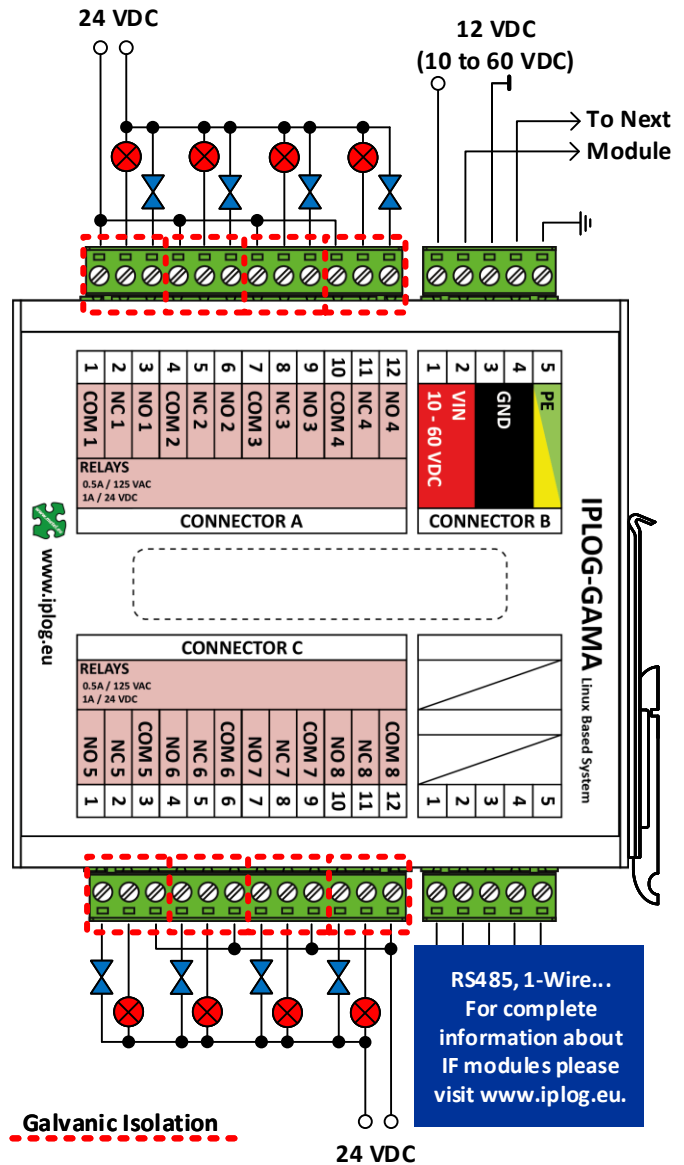

- (1) Does not apply to the RE-8.2E module.
- (2) RE8.2E module is not possible to use as a standalone module. Module is designed only for installation on motherboard IPLOG-G1, G2, G2E and G3.

Location and Designation of Connectors and LEDs

NOTE: The order of the terminal numbers in the table below corresponds to the order of the terminal numbers found on the device.

CONNECTOR A			LEDS	
12	NO 4	Normally Open	RE4	Default Log 1 = Lights / Programmable
11	NC 4	Normally Closed		
10	COM 4	Common Terminal of NOC Relay 4		
9	NO 3	Normally Open	RE3	Default Log 1 = Lights / Programmable
8	NC 3	Normally Closed		
7	COM 3	Common Terminal of NOC Relay 3		
6	NO 2	Normally Open	RE2	Default Log 1 = Lights / Programmable
5	NC 2	Normally Closed		
4	COM 2	Common Terminal of NOC Relay 2		
3	NO 1	Normally Open	RE1	Default Log 1 = Lights / Programmable
2	NC 1	Normally Closed		
1	COM 1	Common Terminal of NOC Relay 1		

CONNECTOR B			LEDS	
5	PE	Earthing Terminal		
4	GND	Power Input – Minus Terminals	PWR	Default Setting: the Power is Connected, LED Lights Up. / Programmable
3		Terminals are Internally Interconnected		
2	VIN	Power Input – Plus Terminals		
1	10-60 V DC	Terminals are Internally Interconnected		

CONNECTOR C			LEDS	
12	COM 8	Common Terminal of NOC Relay 8		
11	NC 8	Normally Closed		
10	NO 8	Normally Open	RE8	Default Log 1 = Lights / Programmable
9	COM 7	Common Terminal of NOC Relay 7		
8	NC 7	Normally Closed		
7	NO 7	Normally Open	RE 7	Default Log 1 = Lights / Programmable
6	COM 6	Common Terminal of NOC Relay 6		
5	NC 6	Normally Closed		
4	NO 6	Normally Open	RE6	Default Log 1 = Lights / Programmable
3	COM 5	Common Terminal of NOC Relay 5		
2	NC 5	Normally Closed		
1	NO 5	Normally Open	RE 5	Default Log 1 = Lights / Programmable

Galvanic Isolation

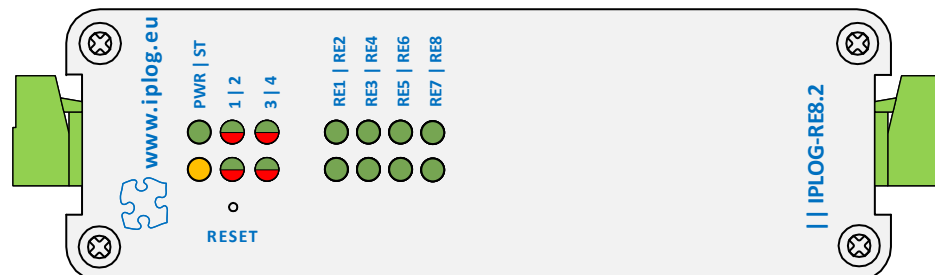

Dimensions

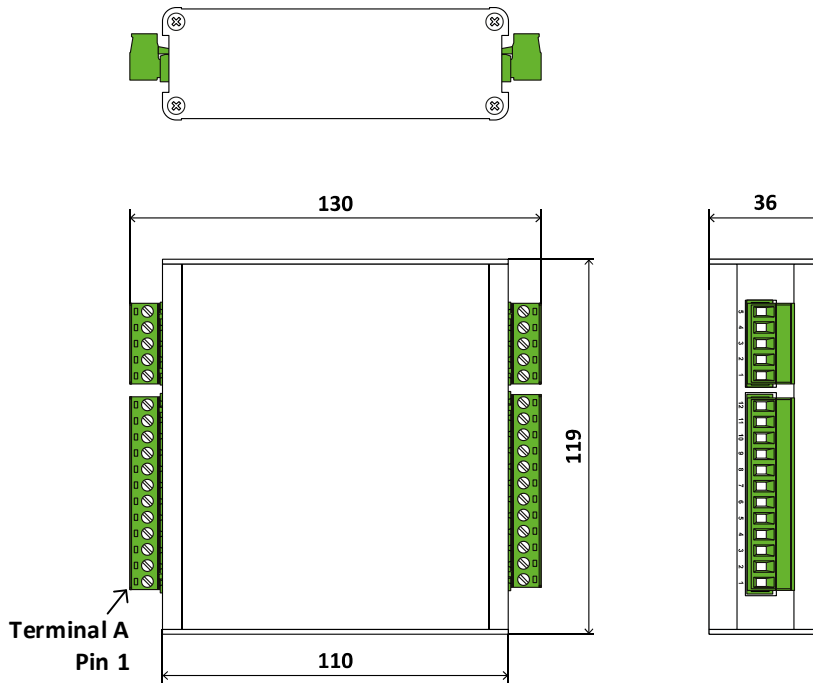

Installation

Flat Surface

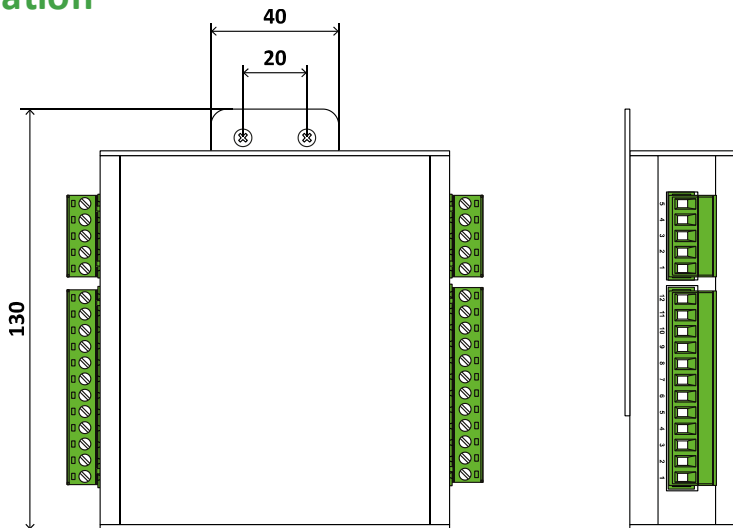

For installation we recommend using M3 screws and a flat surface holder from accessories.

DIN35 Surface

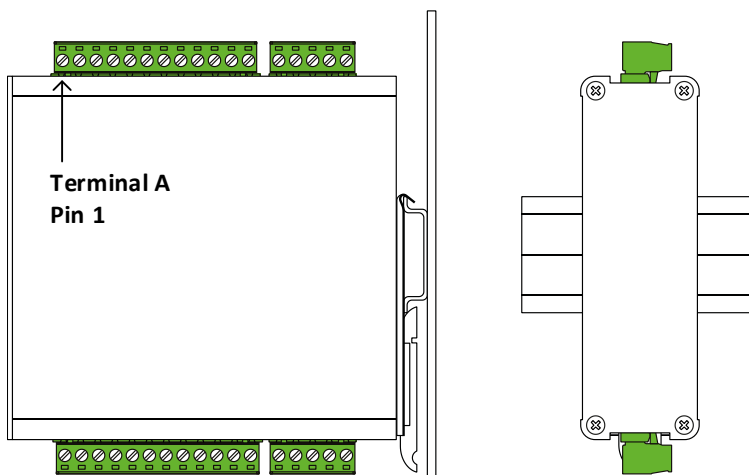

For installation we recommend using M3 screws and DIN35 holder from accessories.

Modbus Registers

Below is a list of available device MODBUS registers. The same register numbers are also used by the MIOS-2 protocol.

Modbus Read / Write (0x17) Function

METEL IO modules have implemented MODBUS function (0x17) Read/Write of Multiple registers. Typically it is required to have two separate requests (and responses) for:

- 1) Writing of outputs via MODBUS function (0x16) Write Multiple Registers
- 2) Reading of inputs via MODBUS function (0x03) Read Holding Registers

This requires a total of 4 frames to be sent over MODBUS. If using 0x17 function only one request is needed for the writing and reading of outputs. This requires a total of 2 frames to be sent over MODBUS.

Default Settings of Communication

Device ID: 1

Baudrate: 115 200

Parity: None

Data bits: 8

Stop bits: 1

	Subject	Channel	Type	R/W	Value	Offset
Relay Output States	COIL Relay 1	DI#01	bit	R	0 = inactive 1 = active	3001
	COIL Relay 2	DI#02	bit	R		3002
	COIL Relay 3	DI#03	bit	R		3003
	COIL Relay 4	DI#04	bit	R		3004
	COIL Relay 5	DI#05	bit	R		3005
	COIL Relay 6	DI#06	bit	R		3006
	COIL Relay 7	DI#07	bit	R		3007
	COIL Relay 8	DI#08	bit	R		3008
	Digital Inputs	DI#16 - DI#01	u16	R	0x0000 - 0x00FF	3001

	Subject	Channel	Type	R/W	Value	Offset
Relay Outputs	Relay Output 1	DO#01	bit	RW	0 = inactive 1 = active	4001
	Relay Output 2	DO#02	bit	RW		4002
	Relay Output 3	DO#03	bit	RW		4003
	Relay Output 4	DO#04	bit	RW		4004
	Relay Output 5	DO#05	bit	RW		4005
	Relay Output 6	DO#06	bit	RW		4006
	Relay Output 7	DO#07	bit	RW		4007
	Relay Output 8	DO#08	bit	RW		4008
	Outputs	DO#16 - DO#01	u16	RW	0x0000 - 0x00FF	4001

	Subject	Channel	Type	R/W	Value	Offset
Device Identification	Product Type		u8[3]	R		1002-04
	Serial Number		u32	R		1005-06
	PCB Version		u32	R		1007-08
	PCB Revision		u16	R		1009
	FW Version Major		u16	R		1010
	FW Version Minor		u16	R		1011
	FW Version - Revision		u32	R		1012-13
	IF#01 Slot State		u16	R	0 = N/A 1 = IF#01 not Inserted 2 = IF#01 Inserted, CRC error 3 = IF#01 Inserted, CRC OK	1021
	IF#01 Product Type		u8[3]	R		1022-24
	IF#01 Serial Number		u32	R		1025-26
IF#01 PCB Version		u32	R		1027-28	
IF#01 PCB Revision		u16	R		1029	
Device Control	Reset		u16	RW	55203 = To Reboot	1201
	Bootloader / Application		u16	R	0x00A – Application, 0x00B – Bootloader	1203
	Restart to Bootloader ⁽¹⁾		u16	RW	617 = To Bootloader else = deactivate bootloader	1204
Device Status	Board Power Voltage #X Value (1<X<3)		u16	R	105 = 10,5V	131X
	Board Temperature		s16	R	-200 = -20,0°C 250 = 25,0°C	1321

⁽¹⁾ to activate the bootloader, it is necessary to write a value of 617 in the registry and restart the device

Relay outputs are capable of switching loads with either AC or DC voltage. Relay Outputs are accessible from METEL IEC 61131-3 IDE or directly from Linux scripts and can be configured independently of each other. Logical state of each output is signaled by the relevant programmable LED diode on the front panel. For details please see the table „Location and Designation of Connectors and LEDs “.

Internal Connection

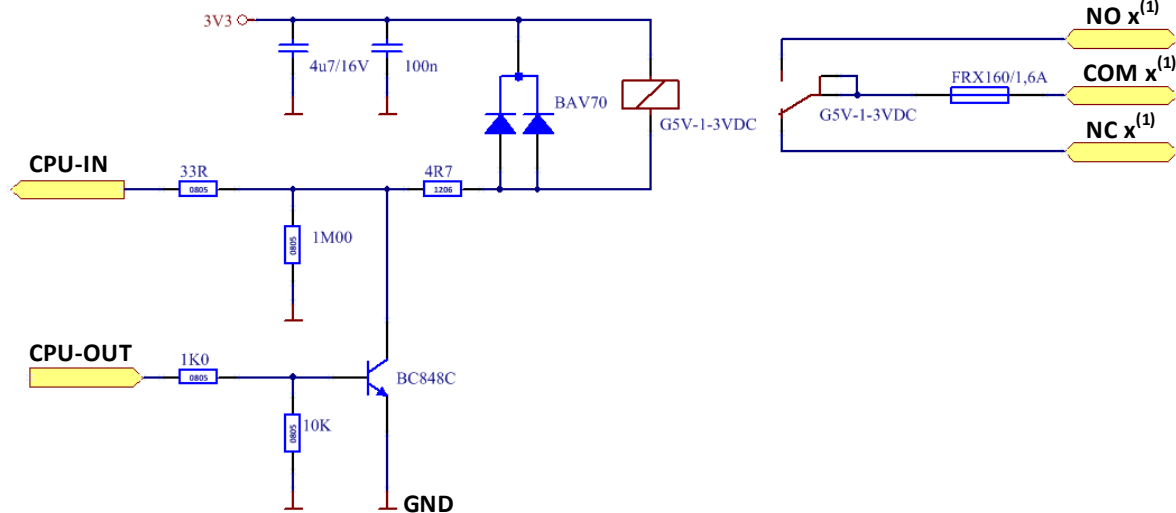

Examples of Connections

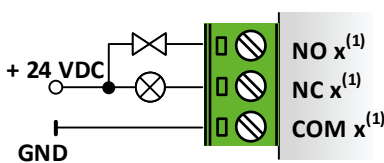

Relay NOC (Changeover) output has a common terminal COM. The two state relay can switch both AC and DC voltages to load. In the non-voltage state are relays terminals NO $x^{(1)}$ – COM $x^{(1)}$ disconnected and NC $x^{(1)}$ – COM $x^{(1)}$ connected. The relay is turned on when program set logic 1 at its coil. When the relay is turned on, corresponding REx⁽¹⁾ LED diode on the front side lights up (in default configuration).



Relay terminals must be protected with an external circuit breaker or fuse to prevent the rated current of the terminal or the load being exceeded. When switching inductive load it is recommended to protect relay outputs with an appropriate external component (e.g. varistor, RC circuit, or diode).

Parameter	Value	Note
Contact Type	NOC	Changeover Relay
Number of Poles	1	
Max. Load	0.5 A / 120 VAC	Resistive Load
	1 A / 24 VDC	Resistive Load
Electrical Lifetime	3,000,000 Operations	
Isolation Voltage	1.000 Vrms / 1 min.	Terminals to Electronic or Case

(1) The letter „x“ replaces the output number.





The PE terminal must be earthed according to the applicable standards in the country of installation. Correct grounding protects personnel against electric shock and improves device immunity from interferences. If dangerous voltage is applied to the terminals, only personnel with appropriate electrical education may perform installation and servicing of the equipment. Before any manipulation with the device, including disconnecting and connecting the terminals, the dangerous voltage must be disconnected.

POWER INPUT

The supply voltage is connected to VIN and GND terminals. The terminals are doubled for easier connection between the modules installed side by side.

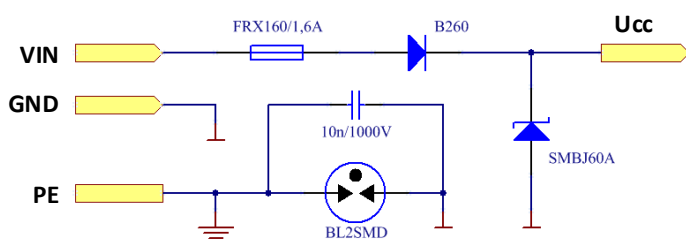
Internal Connection of POWER INPUT



 The cover of the device is galvanically connected to the PE terminal which is galvanically isolated from the device electronic. It allows the user to use the device even in systems with a grounded + pole.

Parameter	Value	Note
Input Voltage Range	10 to 60 VDC	
Surge Protection	600 W	10 / 1000 μ s
Short Circuit Protection	Polyswitch	
Reverse Polarity Protection	Diode	

IO modules include one IF slot which can be used for IF modules. The main purposes of the IF modules are to provide:

- ❖ RS485 connectivity if the IO module board is used in the standalone addressable IO module communicating with PLC via the RS485 bus
- ❖ Provides serial interfaces for communication with other systems
- ❖ Additional inputs and outputs into system

Standalone IF Module

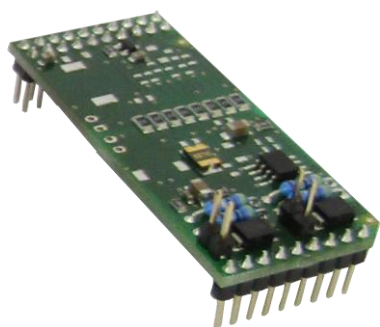

IF module Installed on a IO Module

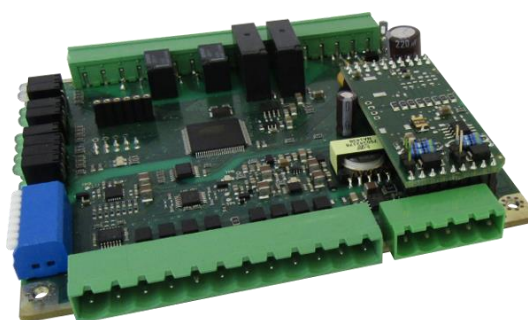

📖 IF modules must be plugged into the IF slot when the power is turned off. After, the power is turned on the new IF module is automatically detected.

📖 When ordering, we recommend using the online configurator available at www.iplog.eu.

Overview Table of IF Modules

ORDERING		CONNECTOR D				
NAME	DESCRIPTION	1	2	3	4	5
IF-01	2x RS485	A1+	B1-	GND	B2-	A2+
IF-01G	2x RS485 ISO	A1+	B1-	GND-ISO	B2-	A2+
IF-02	2x RS232	Rx1	Tx1	GND	Rx2	Tx2
IF-02G	2x RS232 ISO	Rx1	Tx1	GND-ISO	Rx2	Tx2
IF-03	RF 868 MHz	TBD	TBD	TBD	TBD	TBD
IF-04G	RS485 ISO, DALI	A+	B-	GND-ISO	-D BUS	+D BUS
IF-05	RS485, 2x INPUTS ⁽¹⁾	A+	B-	GND	BI 2	BI 1
IF-06	AUDIO	OUT R	OUT L	GND	IN R	IN L
IF-07G	RS485 ISO, 1-Wire	A+	B-	GND-ISO	1-Wire	5V0-ISO
IF-08G	Profibus	A	B	GND-ISO	GND-ISO	5V0-ISO
IF-09	M-Bus	M-Bus+	M-Bus+	GND	M-Bus-	M-Bus-
IF-10	KNX	BUS+	BUS+	NC	BUS-	BUS-
IF-11	Wiegand, 2x INPUTS ⁽¹⁾	Data 0	Data 1	GND	BI 2	BI 1
IF-12	4x INPUTS ⁽¹⁾	BI 4	BI 3	GND	BI 2	BI 1
IF-13	RS232 (CTS, RTS, Rx, Tx)	CTS	RTS	GND	Rx	Tx
IF-13G	RS232 (CTS, RTS, Rx, Tx) ISO	CTS	RTS	GND-ISO	Rx	Tx
IF-14G	4x DIGITAL INPUTS (24V)	ISO DI 4	ISO DI 3	GND-ISO	ISO DI 2	ISO DI 1
IF-15	4x OC (NPN) OUTPUTS	OC 4	OC 3	GND	OC 2	OC 1
IF-15G	4x OC (NPN) OUTPUTS ISO	ISO OC 4	ISO OC 3	GND-ISO	ISO OC 2	ISO OC 1

⁽¹⁾ Alarm / 5V Digital Inputs

ISO = Isolated

TBD = To be Determined

IF- That way labeled IF modules are suitable for standalone IO modules. They are always connected to a PLC or LAN-RING switch via the RS485 bus.

📖 Into RE8.2E module is not possible insert IF module.